

Additional Plug 'n' Play compatible items.
 For more items visit www.plsgroup.co.uk



BC17018 - Prewired White Mains Flush Inlet



PO112 - Prewired Surface Mounted Inlet



BC17013 - 3Mtr 230v Extension
 BC17019 - 2Mtr 230v Extension
 BC17020 - 1Mtr 230v Extension



BC17015 - Prewired C-Line 230v Socket



BC17014 - Prewired Switched 230v Fridge Socket



JE980 - Easy Connect White



PO243 - C-Line Touch Panel Switch



PO106D - 25Mtr Mains Hook Up Cable



PO129 - Wireless Charger Point



Distributed by
 Pennine Leisure Supplies Ltd, HX6 2WA
 email: info@plsgroup.co.uk

BCA

Manufactured by
 BCA Group Ltd, HX5 9HF
 email: info@bcagroup.co.uk

Issue 1/2020

COMPACT PDU SYSTEM & VEGAS CONTROL PANEL

PDU CONVERTER HARNESS KIT



MADE IN BRITAIN



IDEAL FOR CAMPER VANS AND HORSE BOXES

Table of Contents

Description of Product.....	2
230V System.....	3
12V System.....	4
12V + 230V Harness.....	6
Schematic.....	7
Installation of the PDU.....	10
Access to the connectors.....	10
Connection to the mains supply.....	10
Ventilation.....	10
Storage.....	11
Servicing.....	11
Vegas Control Panel.....	11
Pressure Water Probe	15

Features about the PDU (Power Distribution Unit)

- 1 x RCD, 2 x MCB- 4 outputs
(not including the power supply) one input connector.
- 150w power supply @13.8V
- 12 replaceable fuses, one poly fuse.
- Power supply isolation switch.
- Circuits:
 - 1) Vehicle Battery
 - 2) Leisure Battery
 - 3) Fridge (permanent circuit)
 - 4) Fridge (Ignition controlled)
 - 5) Lights (Master & Lights controlled)
 - 6) Aux (Master controlled)
 - 7) Hob (Master controlled)
 - 8) Heaters (Master Controlled)
 - 9) Toilet (Master Controlled)
 - 10) Pump (Master and pump controlled)
 - 11) Spare Perm
 - 12) Ignition In/Ignition out
 - 13) Control panel (permanent circuit)
 - 14) Control panel (Ignition controlled)

WARNING
All electrical work must be carried out by a competent person.

230V Protection Devices

MADE IN BRITAIN

bsi. ISO 9001:2015 Quality Management

bsi. ISO 14001:2015 Environmental Management

2 **POWERPART**
*No1 for Converters

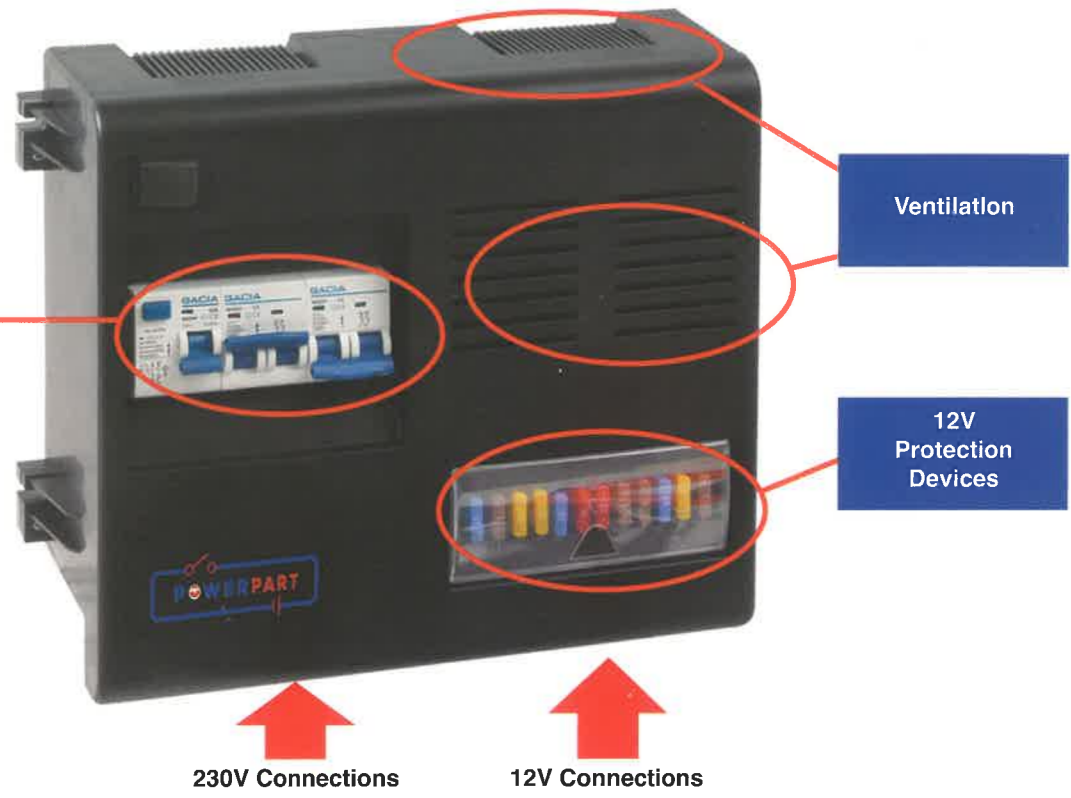

230V Connections

12V Connections

All electrical work must be carried out by a competent person.

230V System

The compact PDU is fitted with two double pole Miniature Circuit Breaker (MCB's) and one Residual Current Device (RCD).

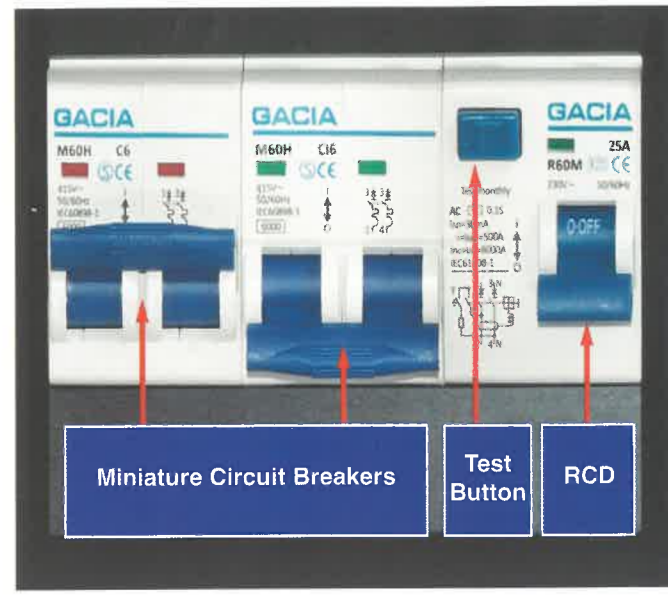

MCB's

MCB's are overload and short circuit protection devices for the 230V system.

To switch the MCB's on they need to be in the up position and the indicator will be red, when in the off position they need to be in the down position and the indicator will show green.

MCB	RATING	CIRCUIT	CONNECTOR
1	6 AMP	Internal Power Supply	N/A
2	16 AMP	Sockets & Appliances	VLR-06R x 2

All electrical work must be carried out by a competent person.

RCD

The RCD is fitted to provide protection against electric shock and measures for imbalance in current flow and will activate if there is leakage to earth either through a person or an appliance, the Compact PDU is supplied with the below label, although we recommend operating the test button every time the vehicle is hooked up to a mains supply.

THIS LABEL TO BE FITTED ADJACENT TO MAIN SWITCH

This installation, or part of it, is protected by a device which automatically switches off the supply if an earth fault develops. Test six-monthly by pressing the button marked 'T' or 'Test'. The device should switch off the supply and should then be switched on to restore the supply. If the device does not switch off the supply when the button is pressed, seek expert advice.

IMPORTANT

This installation should be periodically inspected and tested and a report on its condition obtained, as prescribed in the IET wiring regulations BS7671 Requirements for Electrical Installations.

Date of last inspection

Recommended date of next inspection.....

Date of next inspection.....

Pt No 730126A

POWERPART
*No1 for Converters

230V Connections

- The two six-way connectors are the outputs from the 16A MCB.
- The four-way connector is the input from the vehicle's mains inlet.
- The main earth is to be connected to the vehicles chassis and gas pipes.

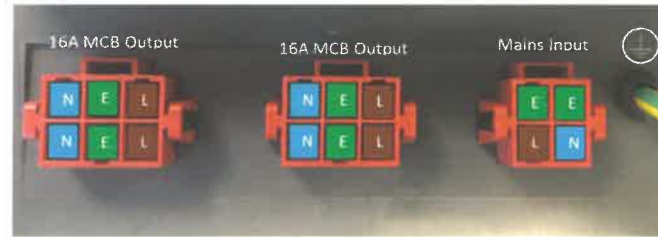

12V System

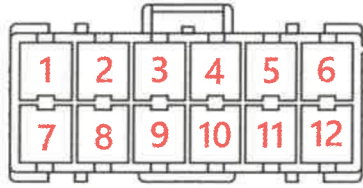

The 12V system incorporates a 150W 13.8Vdc power supply which can be disconnected by the integrated switch and a 12V PCB which distributes power to various circuits via relays and fuses.

The following table's show the pin/fuse and circuit information

Pin	Fuse	Max Fuse Rating	Circuit	Additional Information
1	F1	15A	Fridge	This is a permanent circuit for a compression fridge
2	F8	10A	Heater	This is a master switch-controlled circuit
3	F10	5A	Hob	This is a master switch-controlled circuit
4	F13*	5A	12v Ignition out	Live when the engine is running**
5	F11	15A	Auxillary	This is a master switched-controlled circuit, linked with pin 11
6	F12	15A	Lights	This is a master switched and lights switched controlled circuit fed off a normally closed relay, linked with Pin 12
7	F5	5A	Permanent	This is a permanent circuit
8	F9	10A	Toilet	This is a master switched circuit
9	F9	10A	Pump	This is a master switched and Pump switched controlled circuit fed off a normally open relay
10	N/A	N/A	12v Ignition in	This is an input pin for the ignition signal
11	F11	15A	Auxillary	This is a master switched-controlled circuit, linked with pin 5
12	F12	15A	Lights	This is a master switched and lights switched controlled circuit fed off normally closed relay, linked with Pin 12

* F13 is a resettable fuse mounted internally on the PCB ** there must be a suitable input on pin 10

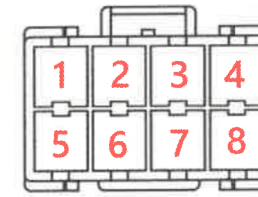

Pin	Fuse	Max Fuse Rating	Circuit	Additional Information
1	F1	25A	Vehicle Battery	Feed from the Vehicle battery, linked with Pin 5
2	N/A	N/A	Ground	To be used as the return for the Vehicle battery
3	F2	25A	Leisure Battery	Feed from the leisure battery, linked with pin 7p
4	N/A	N/A	Ground	To be used as the return for the Leisure battery
5	F1	25A	Vehicle Battery	Feed from the Vehicle battery, linked with pin 1
6	N/A	N/A	Ground	To be used as the return for the Vehicle battery
7	F2	25A	Leisure Battery	Feed from the leisure battery, linked with pin 3
8	N/A	N/A	Ground	To be used as the return for the Leisure battery

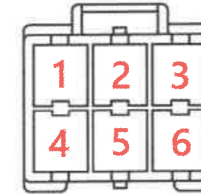

Pin	Fuse	Max Fuse Rating	Circuit	Additional Information
1	N/A	N/A	Ground	Return paths for circuits
2	N/A	N/A	Ground	Return paths for circuits
3	N/A	N/A	Ground	Return paths for circuits
4	N/A	N/A	Ground	Return paths for circuits
5	N/A	N/A	Ground	Return paths for circuits
6	N/A	N/A	Ground	Return paths for circuits

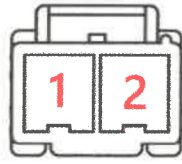

Pin	Fuse	Max Fuse Rating	Circuit	Additional Information
1	N/A	N/A	Ground	Return to 3 stage fridge
2	F6	25A	Fridge	Feed for 3 stage fridge, ignition controlled

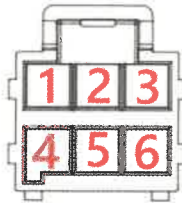

Pin	Fuse	Max Fuse Rating	Circuit	Additional Information
1	F3	5A	Control Panel	This is a permanent circuit.
2	F7	5A	Control Panel	This circuit is control by the ignition and has no power when the engine is running
3	N/A	N/A	Ground	To be used as the return for the control panel
4	N/A	N/A	Master Return	Master Switch return from the control panel
5	N/A	N/A	Lights Return	Master lights switch return from the control panel
6	N/A	N/A	Pump Return	Master pump switch return from the control panel

12 + 230V Harness

The compact PDU is supplied with a "plug and Play" 230V harness and 12V harness which has been designed for easy installation.

230V Harness

The 230V harness comprises of:

- One 3Mtr Mains lead to be connected to the PDU and mains inlet
- Four 2Mtr cables with connectors on both ends for connection to the PDU and compatible c-line sockets and extensions.
- An earth cable to be connected from the PDU to the chassis and gas pipes.

12V Harness

The 12V Harness comprises of a fully built harness fitted with connections to the PDU and to other circuits and appliances

- Water Probe (optional)
- 2 x lights circuit with 6.3 female and hard boot connections.
- 2 x Aux circuits with 6.3 female and hard boot connections.
- Pump with 6.3 female and hard boot connections.
- Toilet with 6.3 female and hard boot connections.
- Hob/Oven with 6.3 female and hard boot connections.
- Heater with 6.3 female and hard boot connections.
- Compression Fridge with 6.3 female and hard boot connections.
- Vehicle Battery and Ignition with 3-way connector.
- Leisure battery with a 2-way connector.
- Control panel with compatible connection for various control panels.
- 12V Ignition feed with 6.3 female and hard boot connections.
- Permanent feed with 6.3 female and hard boot connections.

230V system

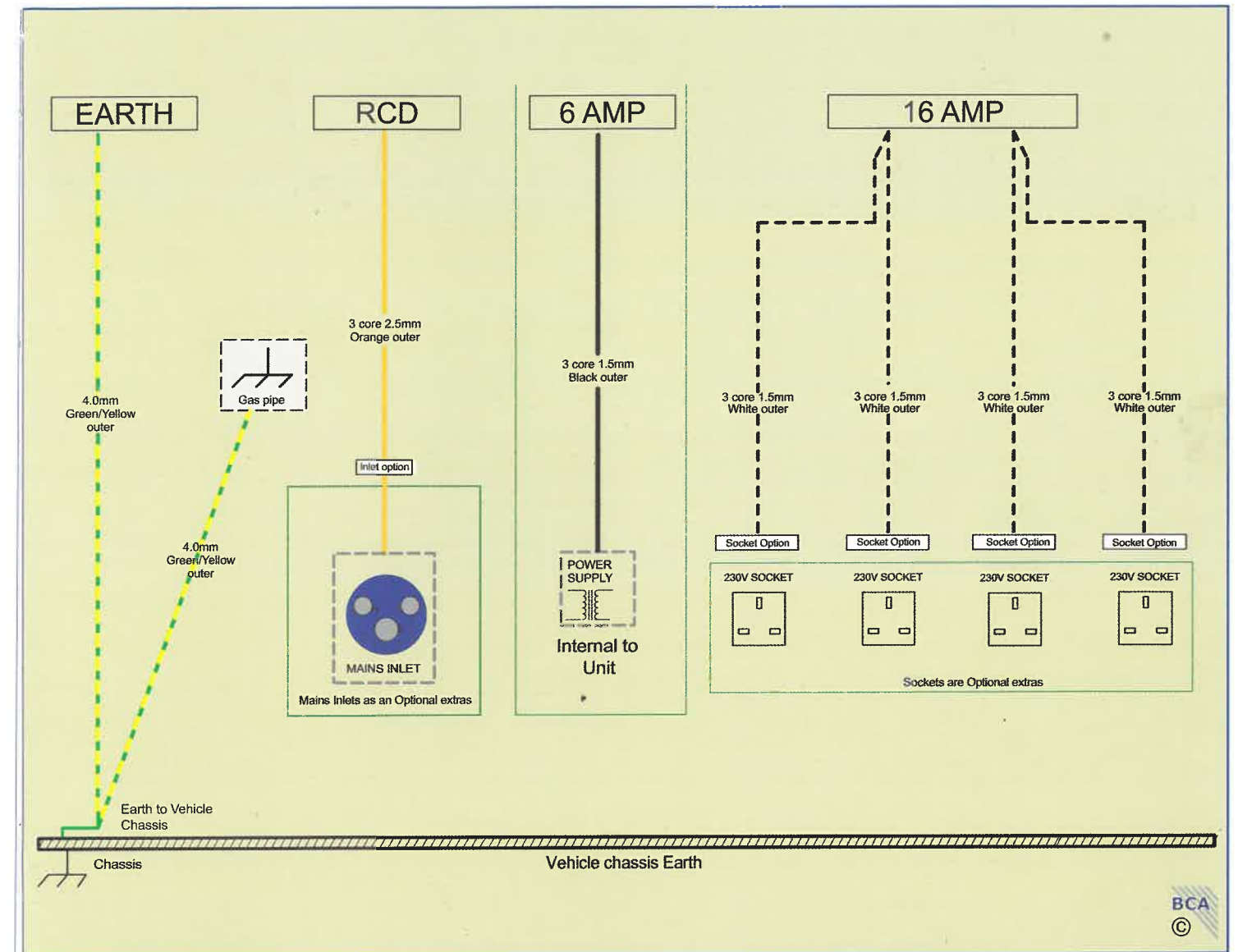

BCA Copyright Notice: This drawing is copyright of BCA Group and may not be reproduced wholly or in part any form without the express prior permission of BCA Group Ltd

PDU Relays

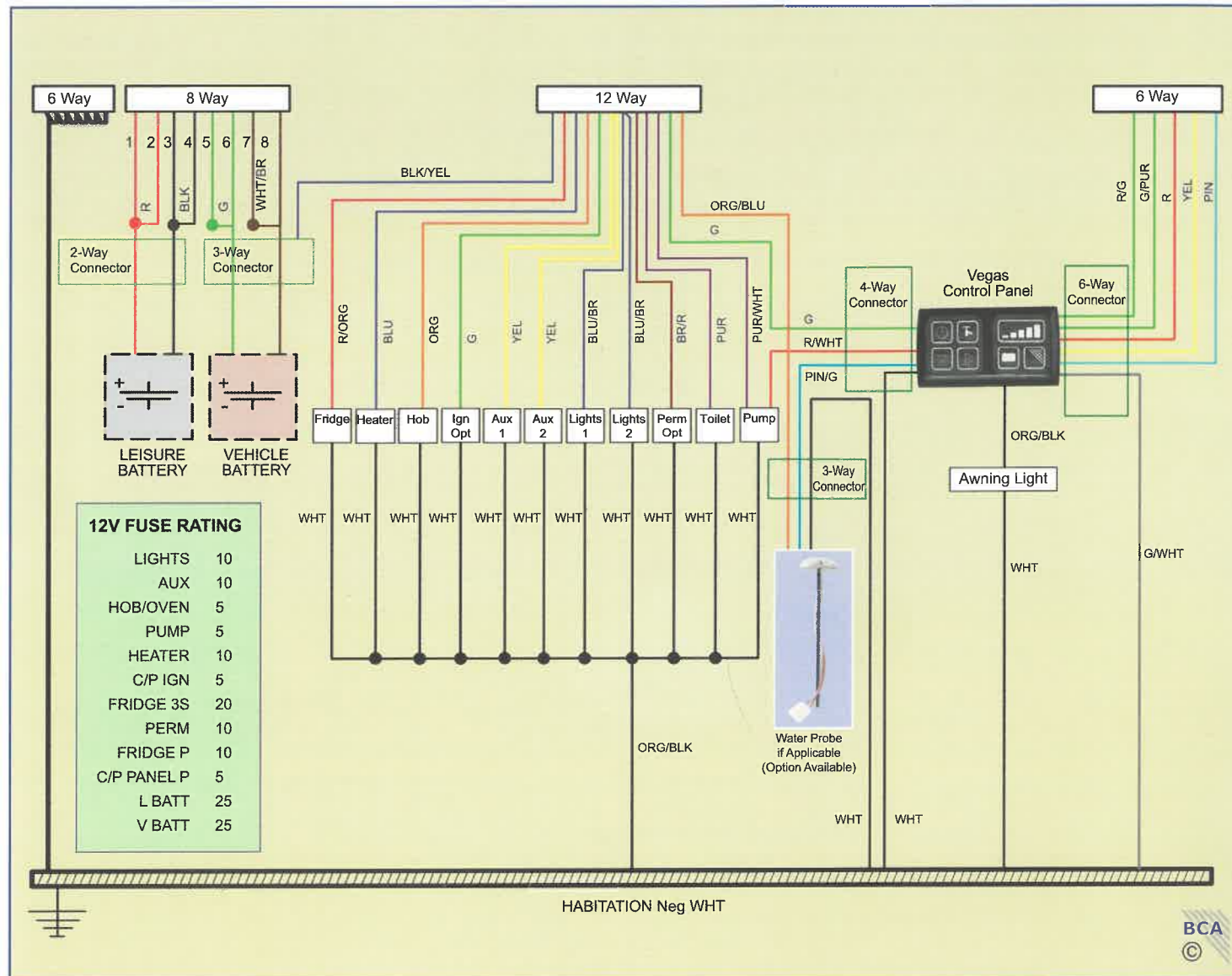

Copyright Notice: This drawing is copyright of BCA Group and may not be reproduced wholly or in part any form without the express prior permission of BCA Group Ltd

All electrical work must be carried out by a competent person.

Wiring Colour Codes

COLOUR	CODE	COLOUR	CODE
RED	R	ORANGE/BLACK	ORG/BLK
BLUE	BLU	RED/GREEN	R/G
GREEN	G	GREEN/BROWN	G/BRN
ORANGE	ORG	PURPLE	PUR
YELLOW	YEL	RED/BROWN	YEL
GREEN/BLACK	G/BLK	GREEN/BLUE	G/BLU
BLUE/BROWN	BLU/BRN	GREEN/PURPLE	G/PUR
GREEN/PURPLE	G/PUR	BLUE/WHITE	BLU/WHT
GREEN/WHITE	G/WHT	ORANGE/GREEN	ORG/G
PINK	PIN	GREEN/WHITE	G/WHT
PINK/BLUE	PIN/BLU	RED/ORANGE	R/ORG
ORANGE/WHITE	ORG/WHT	BLUE/BLACK	BLU/BLK
RED/WHITE	R/WHT	BLUE/RED	BLUE/RED
GREY/BLACK	GR/BLK	GREEN/YELLOW	G/YEL
BLACK/WHITE	BLK/WHT	BLACK	BLK
YELLOW/BLACK	YEL/BLK	WHITE	WHT
PINK/YELLOW	PIN/YEL	BROWN	BRN
PINK/GREEN	PIN/G	GREY	GR
PINK/WHITE	PIN/WHT	WHITE/BROWN	WHT/BRN
YELLOW/WHITE	YEL/WHT	GREY/WHITE	GR/WHT
BLUE/YELLOW	BLU/YEL	GREY/PINK	GR/PIN

Copyright Notice: This drawing is copyright of BCA Group and may not be reproduced wholly or in part any form without the express prior permission of BCA Group Ltd

All electrical work must be carried out by a competent person.

Installation of the PDU

Ventilation

The PDU requires a minimum surrounding clearance of 75mm around the ventilation slots.

The **PDU MUST** be installed as such that external heat sources will not have a detrimental effect on the normal operation of the unit.

Fixing of the PDU

All four fixing points **MUST** be used to secure the PDU to prevent damage to the unit from vibration.

The fixing lugs are mirrored on the opposite side of the PDU. Care must be taken to give adequate space for the bend radius of the cable that is being installed.

Access to connectors

The PDU should be installed in such a way that access to the connectors are only accessible by the use of a tool either by location or an enclosure securely fastened.

Connection to the mains supply

Connection of the PDU to the mains supply* should be made with the supplied cable connected to an inlet** enclosed in a suitable enclosure.

Dimensions of the PDU

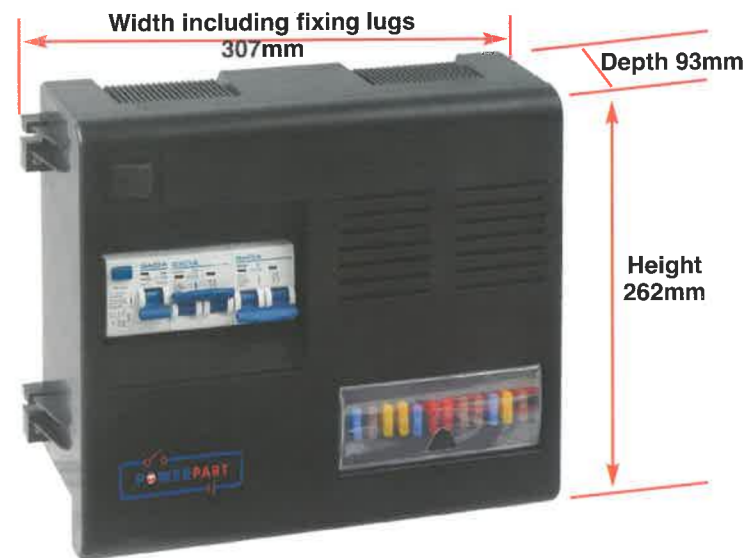

Fixing Points of the PDU



* Ensure the mains supply is switched off before connecting the PDU to the mains
** see www.plsgroup.co.uk for a range of inlets.

All electrical work must be carried out by a competent person.

Storage of the PDU

The PDU **MUST** be stored in a dry storage area suitable for storing electrical and electronic equipment.

Servicing of the PDU

The RCD and MCB's should be checked at the annual service for loose connections on the conductors and busbars.

All electrical work must be carried out by a competent person

The earth terminal should be checked at the annual service for loose connections.

The fixing lugs on the casing should be checked for loose fixings and damage at the annual service.

The 12V fuses should be checked for correct installation at the annual service.

Button Panels

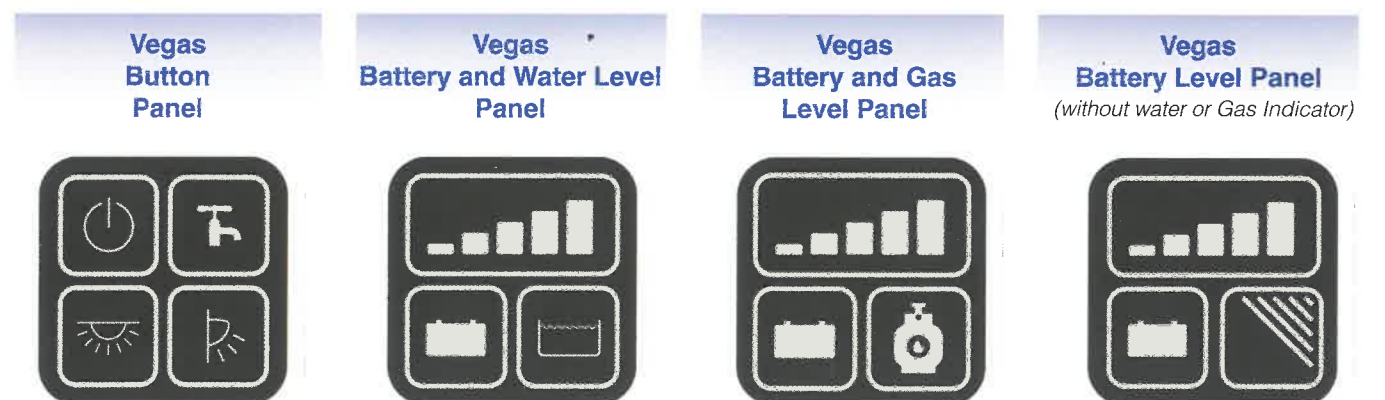

All electrical work must be carried out by a competent person.

Vegas Control Panel Range User Manual

Table of Contents

Vegas Button Control Panel:.....	12
Vegas Voltmeter with Water Level Panel:.....	12
Vegas Voltmeter with Gas Level Panel:.....	14
Vegas Voltmeter Battery Measurement Only Panel:.....	14

Overview

The Vegas Control Panel range allows the user a central or distributed point to check:

- Leisure vehicle battery voltage
- Waste tank full status
- Water tank level measurement
- LPG tank volume measurement

The Vegas Control Panel range allows the user to:

- Switch on/off all non-essential electrical appliances & accessories
- Force the pump to run (for purging the pipes)
- Switch on/off the light circuits
- Switch on/off the awning light
- Switch on/off the pump system

The Vegas Control Panel range has visual alerts for:

- Waste tank full indication
- Pump running indication

Vegas Button Control Panel

Vegas Voltmeter Control Panel



Master Button

When the Master Button is pressed, the control panel will switch power to all non-essential accessories.

- Some features, such as lights, will need the Master Button to be switched on to work.

Lights Button

When the Lights Button is pressed, the control panel will switch power to all the interior lights.

- The Master Button must be switched on for this button to affect the lights.

Pump Button

When the Pump Button is pressed, the control panel will switch power to the water pumps.

- Holding down the Pump Button forces the internal pump to run regardless of tank level. This is to purge the water system.

Awning Button

When the Awning Button is pressed the control panel will switch power to the exterior awning light.

- The Master Button must be enabled to control the awning light.

Vegas Voltmeter with Water Level Panel

Vegas Voltmeter Control Panel

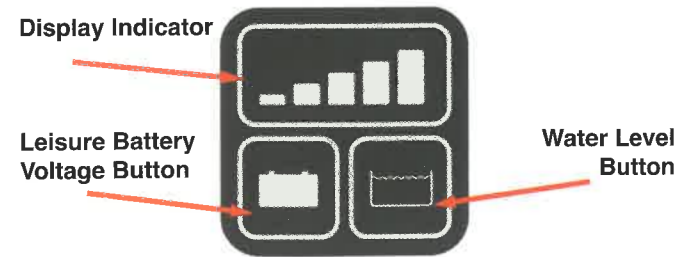

Display Indicator

The Display indicator on the Vegas Voltmeter Panel is used to display the Leisure Battery voltage and the Water level, depending on which button is pressed, also depending on the model it will display sensor alerts.

- If a waste tank is fitted, the lowest indicator (**Red**) will illuminate when the waste tank is full.
- When the pump is running the 5th indicator (**Green**) will illuminate to indicate that the pump is currently running.

Leisure Battery Voltage Button

When the Leisure Battery Voltage Button is pressed, the Display Indicator will illuminate and display the voltage level of the Leisure Battery.

Note: This will override indicator alerts.

Water Level Button

When the Water Level Button is pressed, the Display Indicator will illuminate and display the water level reading inside the water tank. The Vegas Voltmeter panel takes a measurement every 8 seconds that the button is held down with the first measurement done as soon as the button is pressed.

If the Water Level Button is released and pressed again within

8 seconds of the last measurement then there will be a delay until a new measurement can be taken. This delay is equal to the time left from the previous measurement and is a maximum of 8 seconds. If more than 8 seconds has passed since the last measurement then it will read and display immediately.

Note: Holding the Water Level Button overrides indicator alerts.

Waiting for 8 second timer to clear

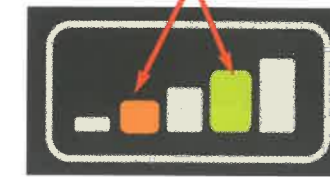

Water Level Calibration

When the water level system is used for the first time it is recommended that the user calibrates the water level system, to calibrate the water level system please follow the points highlighted below:

- Make sure that the water tank has been filled to the desired maximum water level before starting the calibration process.

Use the following steps to calibrate your Control Panel.

- Hold down both the Voltage Button and Water Level Button for 6 to 8 seconds to enter calibration mode.
- When you are in calibration mode, the Display Indicator will light up depending on which water probe you have installed.
- When the panel has entered calibration mode (One of the 3 options show opposite is being displayed) please release the Voltage Button and Water Level Button.

All electrical work must be carried out by a competent person.

Calibration Modes - One of Three Options

Option - Pressure Probe



Option - Resistive Probe



Option - 5 Prong Probe



- If you wish to cancel the calibration process, press and hold Leisure Battery Voltage Button for one second.

- When the calibration process is cancelled the display will flash two times.

- To start the calibration process, press and hold the Water Level Button for half a second and then release the button.

- If the calibration process was successful, the display will flash three times.

- If the calibration process is successful, the Control Panel will restart and be ready to use.

- If the calibration process was unsuccessful, the display will flash two times.

- If the calibration process fails, restart the calibration process again ensuring that the water tank is full.

Note: If the calibration process fails and the display flashes 2 times the value is still saved as its calibration value.

Vegas Voltmeter with Gas Level Panel

Vegas Voltmeter and Gas Panel



Display Indicator

The Display indicator on the Vegas Voltmeter with Gas Level Panel is used to display the Leisure Battery voltage and the LPG level, depending on which button is pressed.

Display Alerts

- If a waste tank is fitted, the lowest indicator (**Red**) will illuminate when the waste tank is full.
- When the pump is running the 5th indicator (**Green**) will illuminate to indicate that the pump is currently running.

Leisure Battery Voltage Button

When the Leisure Battery Voltage Button is pressed, the Display Indicator will illuminate and display the voltage level of the Leisure Battery.

Note: This will override indicator alerts.

Gas Level Button

When the Gas Level Button is pressed, the Display Indicator will illuminate and display the gas level reading inside the gas tank.

Note: This will override indicator alerts.

Vegas Voltmeter Battery Management Only Panel

Vegas Voltmeter Battery Measurement only Panel



Display Indicator

The Display indicator on the Vegas Voltmeter Panel is used to display the Leisure Battery voltage.

Display Alerts

- If a waste tank is fitted, the lowest indicator (**Red**) will illuminate when the waste tank is full.
- When the pump is running the 5th indicator (**Green**) will illuminate to indicate that the pump is currently running.

Leisure Battery Voltage Button

When the Leisure Battery Voltage Button is pressed, the Display Indicator will light up and display the voltage level of the Leisure Battery. The button on the right of the panel is not used on this panel.

Note: This will override indicator alerts.

Unused Button

The right-hand button on this panel is unused, pressing this button will not cause anything to happen.

All electrical work must be carried out by a competent person.

Pressure Water Probe

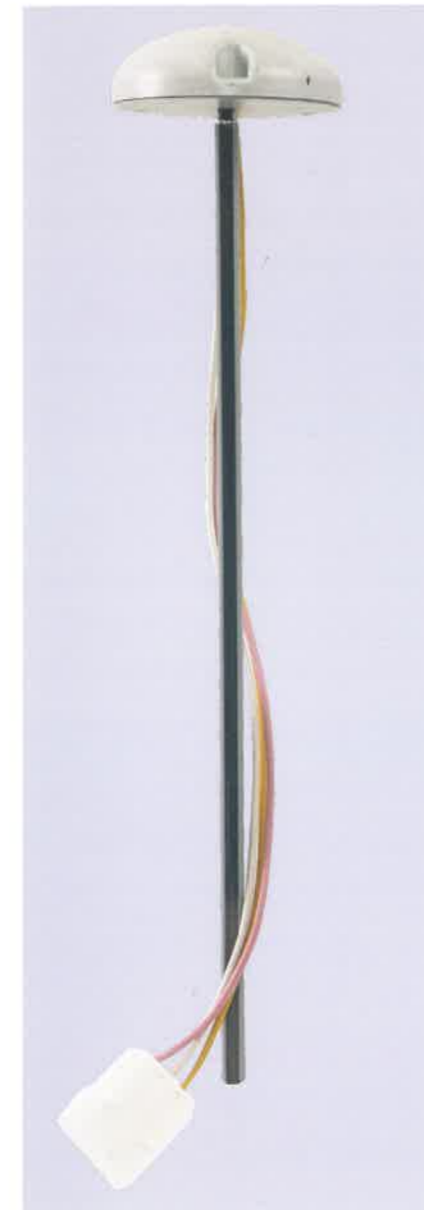

The pressure probe can be cut to any length (we recommend to leave a 10mm gap between the bottom of the tank and the bottom of the probe) and then calibrated with the control panel following the instructions in the control panel section, care must be taken when cutting to length that the pipe is clear.

The probe uses the airpressure in the pipe to measure the level of water, as the water increases the pressure in the pipe increases giving the control panel its readings

To install the water probe, drill a 10mm hole in the water tank, put a small bead of sealant around the hole leaving a gap of 10mm, insert the probe into the tank and secure with screws using the three fixing holes, then connect the probe to the harness using the three-way connector, care must be taken to not block the cable exit hole as this is used to measure the pressure in the probe against the outside atmospheric pressure.

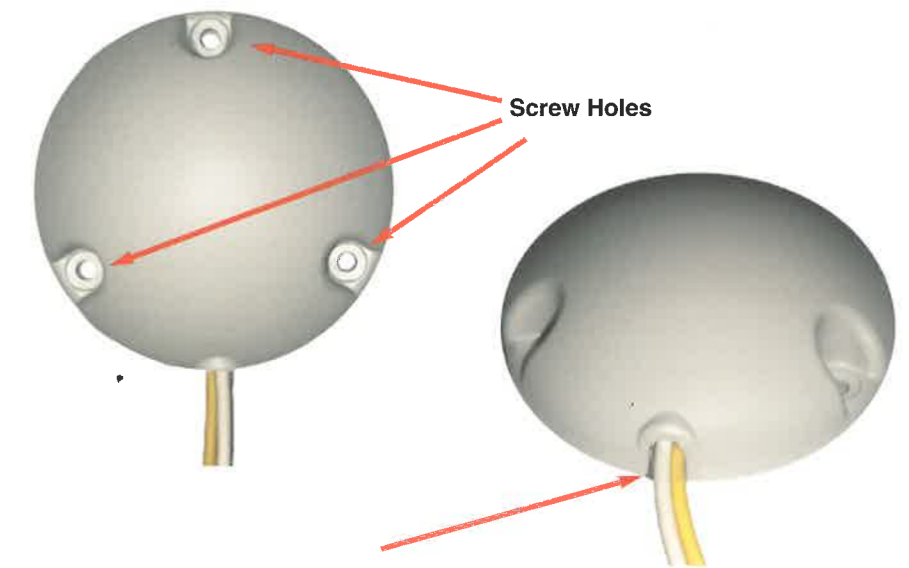

Leave cable hole clear Do NOT block with sealant

Note: if there is no overflow pipe or air release valve in the water tank for air to get in/out of the tank when filling or emptying this will have a detrimental effect on how the probe will work.

All electrical work must be carried out by a competent person.