

MADE IN FRANCE

www.trigano-camping.com

TRIGANO

CONTENTS



GUARANTEE OF QUALITY	4-5
GALLÉON	6-7
ODYSSÉE SPORT	8-9
ODYSSÉE PLUS	10-11
ALPHA	12-13
CAMPRIDER	14-15
SPECIFICATIONS	16-17
FITTINGS AND OPTIONS	18-19

WHY CHOOSE BETWEEN COMFORT AND NATURE?

Yes, you can have holidays in the open air without giving up anything in terms of comfort! Through constantly updating the technical and functional innovations in its range of trailer tents, Trigano makes sure that your holiday comfort is a top priority. They are easy and quick to set up, with spacious interiors. The shapes and colours are always changing, and they come with a variety of options and handy features.

Find out about the full 2019 collection here in this catalogue. More detailed information, such as videos of our products and a list of dealers in your area, can be found on our new website: www.trigano-camping.com

Want to get close to nature? Whether with family or friends, or just the two of you, there is sure to be a model in our range that will suit you, making for carefree and relaxing holidays.

What if your holidays were to become synonymous with perfection?

DISCOVER OUR WORKSHOPS



And learn out about our trailer tent production process in this video.

Install an application on your smartphone to read QR Codes. You can then access our videos in a single click.

THE DETAILS THAT MAKE ALL THE DIFFERENCE



EASY TO TOW

Once closed, a Trigano trailer tent is the size of a standard trailer. It can be towed by most types of car, even the smallest models, offering almost no wind resistance. It is also easy to store in winter.

KITCHEN UNIT

All of our models are available with or without kitchen units. These units are attached at the rear of your trailer tent and offer all the space and equipment you need. They are mobile so that you can cook outside your awning when it is nice and sunny (except the fixed kitchen unit on the Alpha model). The Odyssée's kitchen can have castors mounted.



SLEEPING COMFORT

Sleep as if you are in your own bed! The bedrooms are made from cotton, which serves as a lining for the main canvas and are fitted with mesh flyscreens and flaps. The mattresses are wide and comfortable and the slat bases are available on most models. Our models offer two separate rooms (except the Alpha) and you can also add extra sleeping areas (under-trailer bedrooms, annexes).



STORAGE SPACE

We know you take a lot of luggage with you on holiday. All our models are equipped with storage spaces for easy transport. And some models offer the all new EASY PACK system making access to luggage easier during stopovers.

GROUNDSHEETS

Acclaimed by our customers, these sheets are attached to the awnings by a zip fastener about 10 cm above the ground. They protect you from moisture and insects, and also prevent wind blowing under the awning. You can remove them and refit them whenever you want.

YOUR HOLIDAYS DESERVE THE BEST!



Trigano trailer tents have been made in Mamers in the Sarthe for over 60 years. Haute couture camping has a name and its reputation is founded on a long-standing tradition.

Our expertise is unique in Europe and is reflected in the **quality of our products**. The sense of perfection that drives our designers is epitomised in the attention we pay in the choice of materials used. The canvas is an essential component of a trailer tent. That's why, for the roofs and walls, we have selected top quality cotton that is resistant to water, tearing, humidity and the tests of time. The canvas is breathable and well-ventilated. We sew our canvas ourselves by hand using knotted stitches for durability in all conditions. The trailers, also constructed in our factories in France, are extremely durable.

We control the entire production line in order to provide trailer tents that stand up to varied weather conditions and are robust, practical and comfortable.

TRIGANO'S COMMITMENT

REDUCING OUR
ENVIRONMENTAL IMPACT WITH



In order to implement a certified environmental approach and manage the life cycle of our products, **Trigano has joined with Texyloop, a collection organisation, to recycle 100% of our PVC canvases**. Recycling is currently the only effective way of limiting our environmental impact and reducing the amount of waste produced. Every ton of new raw material produced by Texyloop recycling gives a corresponding saving in resources and energy. Texyloop is a fully operational industrial recycling process at the heart of a Europe-wide collection network. **Texyloop enables 100% recycling of the components of textiles and promotes the emergence of activities for reusing materials in new applications.**

EUROPEAN CERTIFICATION,
A MARK OF TRUST

All our trailer tents are certified to current European standards and meet all the latest road safety requirements. It is therefore possible to use our trailer tents within all EU member countries.



GALLEON



RESIDENTIAL



QUICK SET-UP:
20 MINS



Easy set-up: with its simple, curved frame.

Very spacious: with 2 large bedrooms, one extra large living room over 3m deep and multiple storage spaces.

Ideal for family use

Modern style: with its curved shape.
Featuring wide windows for maximum light, all fitted with blackout blinds.

Dark roof on bedrooms to dim the light.

Choice of: External storage unit (box version) or EXTERNAL KITCHEN UNIT (GL VERSION).

SPECIFICATIONS

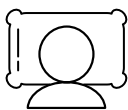

NUMBER OF
BEDS: 2



FLOOR AREA:
21 M²



ZIPPED
GROUNDSHEET



OUTDOOR
KITCHEN UNIT
(ON GL VERSION)

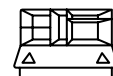

OUTDOOR
STORAGE UNIT
(ON BOX VERSION)

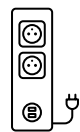

220V PLUG/USB
PORT POWER
SUPPLY (OPTION)

FABRICS



SET UP

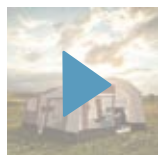

SCAN
THIS
CODE
AND WATCH THE
SET-UP VIDEO

SPACIOUS!

THE GALLEON TRAILER TENT FEATURES ONE OF THE MOST SPACIOUS LIVING ROOMS.



STANDARD VERSION

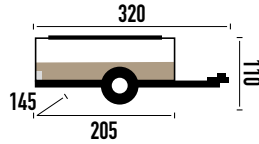

BOX VERSION

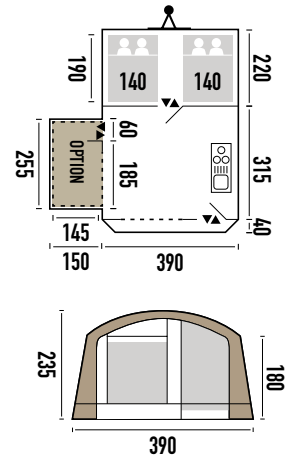
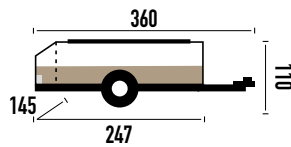

MOCHA VERSION



Galleon + optional bedroom annex



Galleon + optional sun canopy



Box version



ODYSSÉE SPORT



TOURING



QUICK SET-UP:
10 MINS



EASY AND QUICK TO SET UP: The awning is attached to the rear and unfolds at the same time as the bedrooms.

COMPACT, lightweight and easy to manoeuvre.

SLAT BASE AXLE WITH BRAKE as standard.

SPECIFICATIONS

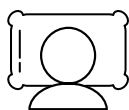

NUMBER OF
BEDS: 2



FLOOR AREA:
19 M²



ZIPPED
GROUNDSHEET



OUTDOOR
KITCHEN UNIT
(ON GL VERSION)



SLAT
BASE

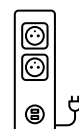

220V PLUG/USB
PORT POWER
SUPPLY (OPTION)

FABRICS

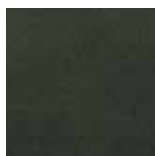

SET UP



SCAN
THIS
CODE
AND WATCH THE
SET-UP VIDEO

FOR FAMILIES!

THE ODYSSEE BUILDS ON THE BASICS OF THE TRAILER TENT, WHILST CONFIRMING ITS FAMILY AND PRICE APPEAL.

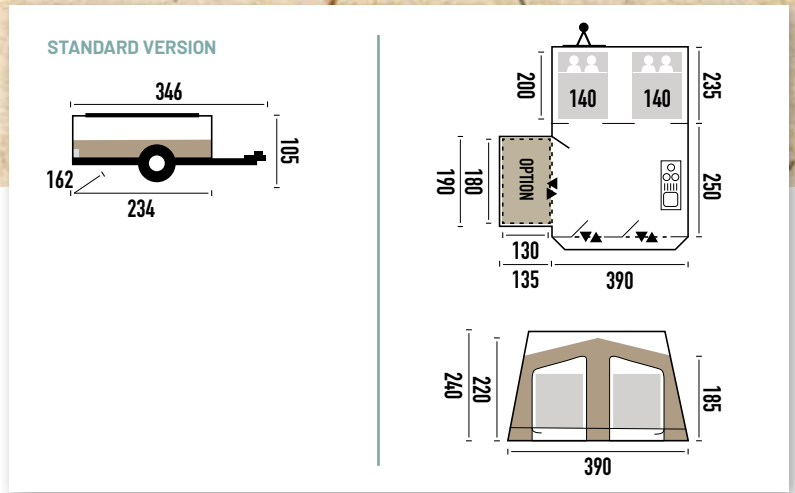

Odyssee with closed blinds



Odyssee + optional sun canopy and bedroom annex



ODYSSEE + optional sun canopy

ODYSSÉE PLUS



TOURING



QUICK SET-UP:
10 MINS



QUICK AND EASY TO SET UP: The awning is attached to the rear and unfolds at the same time as the bedrooms.

BRIGHT FRONT with PVC windows.

SKYLIGHT for more light.

SIDE DOOR PANELS: With mesh flyscreen window and door.

COMPACT, lightweight and easy to manoeuvre.

SLAT BASE AXLE WITH BRAKE as standard.

COMFORTABLE MATTRESS with quilted layer.

INTERIOR MUD FLAP.

SPECIFICATIONS

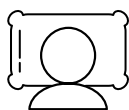

NUMBER OF BEDS: 2



FLOOR AREA: 19 M²



ZIPPED GROUND SHEET



EASY PACK



OUTDOOR KITCHEN UNIT (ON GL VERSION)

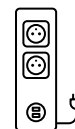

220V PLUG/USB PORT POWER SUPPLY (OPTION)



SLAT BASE

FABRICS



SET UP

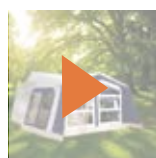

SCAN THIS CODE AND WATCH THE SET-UP VIDEO

MORE FEATURES!

WITH MORE FEATURES THAN THE ODYSSEÉ, THE ODYSSEÉ PLUS IS READY TO ENJOY IN A MATTER OF MINUTES.



STANDARD VERSION

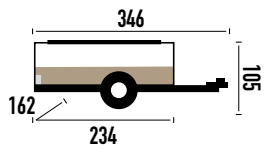

GL VERSION

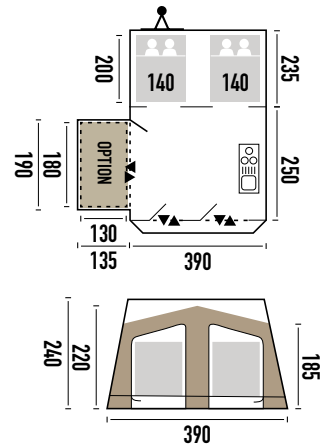
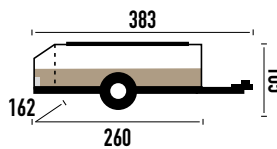

ODYSSEÉ + optional sun canopy with front panels



ODYSSEÉ with detached panels



ODYSSEÉ + optional sun canopy (detached front)



Easy Pack System

ALPHA



TOURING



QUICK SET-UP:
3 MINS



QUICK SET-UP in one step.
RIGID COVER with built-in rack.
SIDE DOOR PANELS: With mesh flyscreen window and door.

BRIGHT FRONT with PVC windows.
SLAT BASE.
WIDE BEDS.

AXLE WITH BRAKE AS STANDARD.
COMFORTABLE MATTRESS with quilted layer.

SPECIFICATIONS

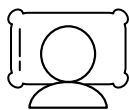

NUMBER OF
beds: 1



FLOOR AREA:
8 M²



OUTDOOR
KITCHEN UNIT
(ON GL VERSION)

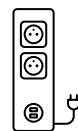

220V PLUG/
USB PORT
POWER SUPPLY



SLAT
BASE

FABRICS



SET UP

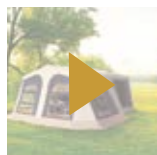

SCAN
THIS
CODE
AND WATCH THE
SET-UP VIDEO

COMPACT!

TOP OF THE RANGE FEATURES ON THE ALPHA MODEL. IT IS ULTRA-COMPACT, WITH SOME GREAT FEATURES FOR ROAMING, WITHOUT COMPROMISING AT ALL ON COMFORT.

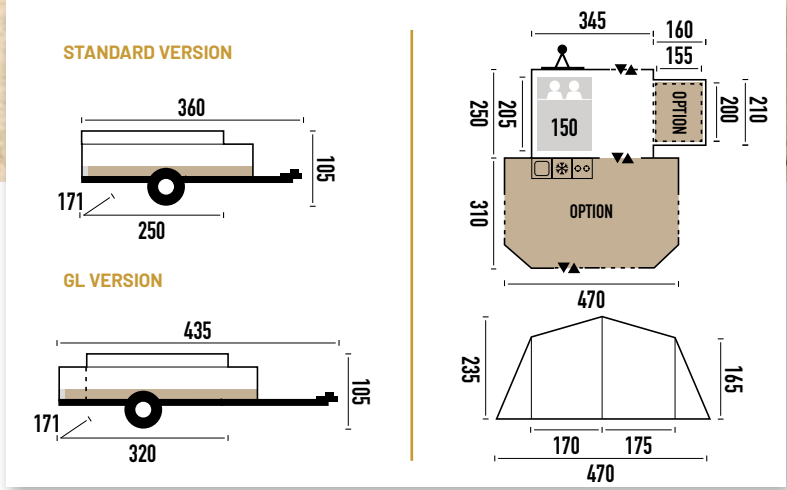

1



2



3



4

CAMPRIDER



TOURING



QUICK SET-UP:
10 MINS



THE CAMPRIDER IS DESIGNED FOR ADVENTURE AND THE GREAT OUTDOORS. IF YOU WANT BIGGER LIVING AREAS, MORE BEDS AND GREATER STORAGE SPACE, YOU WILL LOVE IT. THE SPACIOUS TRAILER FEATURES AN AXLE WITH BRAKE AND A SPARE TYRE.

Walls and front detach with zips.
Mesh flyscreen on doors and windows.
Spacious bedroom.
Comfortable mattress with 15 cm-thick quilted layer.

Tent tray can be unlatched and the Easy Pack removed when using the trailer by itself.

SPECIFICATIONS

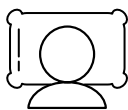

NUMBER OF
BEDS: 1



SLAT
BASE



EASY
PACK

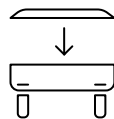

REMOVABLE TENT
TRAY



OPTIONAL
KITCHEN
UNIT

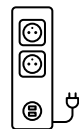

220V PLUG/USB
PORT POWER
SUPPLY (OPTION)

FABRICS

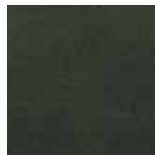

SET UP

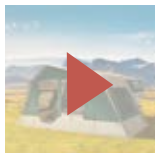

SCAN
THIS
CODE
AND WATCH THE
SET-UP VIDEO

2 IN 1!

THIS INNOVATIVE PRODUCT MEANS YOU CAN TURN YOUR TRAILER TENT INTO A SIMPLE TRAILER. MADE IN TRIGANO'S FACTORIES IN FRANCE, THIS ROBUST YET STABLE TRAILER MAKES ITSELF USEFUL IN A NEW WAY WHEN YOU RETURN FROM HOLIDAYS.

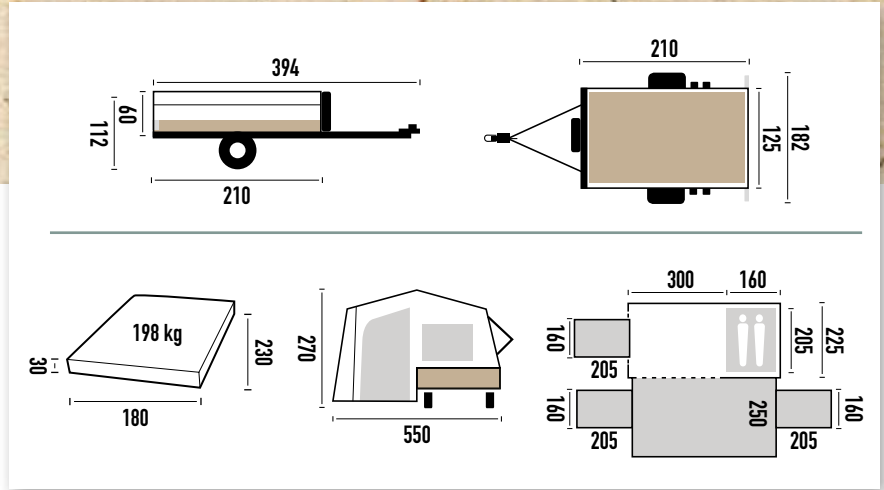

Camprider + extension



Camprider without extension



Trailer + sleeping platform



Easy Pack system



Trailer alone

SPECIFICATIONS

		GALLEON		ODYSSÉE SPORT	ODYSSÉE PLUS		ALPHA		CAMPRIDER	
		STD	GL	STD	STD	GL	STD	GL		
SPECIFICATIONS										
ROOF FABRIC	Quality	Cotton 280 g/m ²		Cotton 320 g/m ²		Cotton 320 g/m ²		Cotton 320 g/m ²		Cotton 320 g/m ²
	Colour	Mocha & beige		Beige		Off-white		Off-white		Beige
WALL FABRIC	Quality	Cotton 280 g/m ²		Cotton 280 g/m ²		Cotton 280 g/m ²		Cotton 280 g/m ²		Cotton 280 g/m ²
	Colour	Mocha & beige		Green & beige		Charcoal grey & off-white		Charcoal grey & off-white		Green & Beige
WALL SKIRT FABRIC	Quality	PVC-coated canvas 350 g/m ²		PVC-coated canvas 350 g/m ²		PVC-coated canvas 350 g/m ²		PVC-coated canvas 350 g/m ²		PVC-coated canvas 350 g/m ²
	Colour	Chocolate		Beige		Pink beige		Pink beige		Beige
	Window	Clear PVC 30/100e		Clear PVC 30/100e		Clear PVC 30/100e		Clear PVC 30/100e		Clear PVC 30/100e
	Groundsheet	PVC-coated canvas 350 gr/m ²		PVC-coated canvas 630 gr/m ²		PVC-coated canvas 630 gr/m ²		PVC-coated canvas 630 gr/m ²		PVC-coated canvas 630 gr/m ²
	Internal bedroom	Polyester cotton 110 g/m ²		Polyester cotton 110 g/m ²		Polyester cotton 110 g/m ²		Polyester cotton 110 g/m ²		Polyester cotton 110 g/m ²
FRAME TUBES	Type	Steel		Steel		Steel		Steel		Steel
	Coating	Zinc-coated & painted		Zinc-coated & painted		Zinc-coated & painted		Zinc-coated & painted		Zinc
	Diameter	Ø22/25 mm		Ø22/25 mm		Ø22/25 mm		Ø22/25 mm		Ø22/25 mm
	Powergrip handles	Yes		Yes		Yes		Yes		Yes
ZIP	Type	YKK		YKK		YKK		YKK		YKK
	Size	Coil zipper No.7 and No.9 Moulded zipper M10		Coil zipper No.7 and No.9 Moulded zipper M10		Coil zipper No.7 and No.9 Moulded zipper M10		Coil zipper No.7 and No.9 Moulded zipper M10		Coil zipper No.7 and No.9 Moulded zipper M10
BEDS										
BED	Number of beds	2		2		2		1		1
	Insulated slat base	No		Yes		Yes		Yes		Yes
	Density	24 kg		24kg firm		24kg firm quilted		24kg firm quilted		24kg firm
	Foam mattress thickness	100 mm		80 mm		80 mm		80 mm		150 mm
	Bed size	140 x 190 cm		140 x 200 cm		140 x 200 cm		150 x 205 cm		160 x 205 cm
EXTRA BEDS	Optional beds	3		2		2		2		3
	2-person under-trailer bedroom	Option		Option		Option		No		No
	Bedroom annexe	Option		Option		Option		Option		Option
	Central bedroom	No		No		No		No		No
LIVABILITY										
SURFACE	Total	21 m ²		19 m ²		19 m ²		8 m ²		7 m ²
COMFORT	Awning	Yes		Yes		Yes		Option 15 m ²		Option 14 m ²
	Sun awning	Optional		Option		Option		Option		No
	Zippered groundsheet	Yes		Yes		Yes		Option		Option
	Mesh flyscreen ventilation	Yes		Yes		Yes		Yes		Yes
	Front mesh flyscreen panel	No		No		Option		No		No
	Bed access ladder	No		No		No		No		Yes
	Tables	No		No		No		No		No

		GALLEON		ODYSSÉE SPORT	ODYSSÉE PLUS		ALPHA		CAMPRIDER	
		STD	GL BOX*	STD	STD	GL	STD	GL	STD	
BODY										
WHEELS	Dimensions	500 x 10		135 R 13	135 R 13		165/70R13		185/R14C	
	Alloy rims	No		No	No		Option		Option	
	Shock absorber	Option		Option	Option		Yes		Yes	
	Spare tyre	Yes		Yes	Yes		Yes		Yes	
	Jockey wheel	Yes		Yes	Yes		Yes		Yes	
AXLE	Type	AL-K0		AL-K0	AL-K0		AL-K0		KNOTT	
	Brakes	Option		Yes	Yes		Yes		Yes	
CHASSIS	Coating	Hot dip galvanisation		Hot dip galvanisation	Hot dip galvanisation		Hot dip galvanisation		Hot dip galvanisation	
	Towbar size	1220 mm		1220 mm	1220 mm		1130 mm		1840 mm	
BODY	Type	Zinc electroplated steel sheet		Zinc electroplated steel sheet	Zinc electroplated steel sheet		Zinc electroplated steel sheet		Aluminium panel	
	Coating	Polyester paint powder coating		Polyester paint powder coating	Polyester paint powder coating		Polyester paint powder coating		-	
	Floor	HBKE with non-slip		HBKE with non-slip	HBKE with non-slip		HBKE with non-slip		HBKE with non-slip	
TRAILER COVER	Type	Tarpaulin		Tarpaulin	Tarpaulin		Cover		Tarpaulin	
	Quality	PVC-coated canvas 630 g/m ²		PVC-coated canvas 630 g/m ²	PVC-coated canvas 630 g/m ²		Fibreglass polyester		PVC-coated canvas 630 g/m ²	
USABLE VOLUME	Storage	892 L	1066 L	750 L	750 L	1006 L	890 L	1560 L	1575 L	
UNLADEN WEIGHT										
ELEC. EQUIP.	220V plug + USB port	Option	Option	Option	Option	Option	Standard	Standard	Option	
WEIGHT	Trailer without brakes	285 kg	-	-	-	-	-	-	-	
	Trailer with brakes	310 kg	345 kg	315 kg	315 kg	365 kg	440 kg	520 kg	340 kg	
	(1) Kitchen or (2) Platform	- (1)	345 kg (1)	- (1)	- (1)	365 kg (1)	- (1)	520 kg (1)	540 kg (2)	
GVW										
STORAGE	France	499 kg	650kg with registration	499 kg or 650kg with registration	499 kg or 650kg with registration		650 kg with registration		1000 kg with registration	
	Depending on country	650 kg		650 kg	650 kg		750 kg		1000 kg	
	Easy Pack	No		No	Yes		No		Yes	
	Towbar storage box 195L	Option		Option	Option		Option	No	No	
	Towbar storage box 300L	Option		Option	Option		Option	No	No	
	Luxury towbar storage box 240L	Option		Option	Option		Option	Standard	No	
	Off-road towbar storage box 240L	Option		Option	Option		Option	No	No	
	Roof-rack	Option max load 80 kg		Option max load 80 kg	Option max load 80 kg		Original max load 50 kg		No	
	Rack adaptor bars	No		No	No		No		No	
	Storage brackets	Option		Option	No		No		No	
KITCHEN										
		Exterior			Exterior			Exterior		Interior
		-	ORIGINAL	-	-	ORIGINAL	-	ORIGINAL	OPTION	
Easy-use wheels	No		-	-	Option		No		No	
Sink	-	Yes	-	-	Yes	-	Yes	Yes		
Water pump	-	No	-	-	Yes	-	Yes	Yes		
Burners	-	3 burners or 2 grill burners	-	-	3 burners or 2 grill burners	-	3 burners or 3 grill burners	2 burners or 2 grill burners		
Drawers	-	No	-	-	Yes	-	Yes	Yes for 2 grill hobs		
Internal shelves	-	Yes	-	-	Yes	-	Yes	No		
Gas bottle holder	-	Yes	-	-	Yes	-	No	No		
Collapsible legs and low shelf	-	Option	-	-	Option	-	No	Yes		

*As the Box is a storage item only, all specifications relating to the kitchen (burners, water pump, etc.) are not applicable to this model. Photo of the Box on page 7.

FITTINGS/OPTIONS

SIDE ANNEX:

Galleon • Odyssee sport • Odyssee Plus • Alpha



Fitted with a window, flap and mesh flyscreen, this annex can be used as a bedroom or toilet cubicle.

UNDER-TRAILER BEDROOM:

Galleon • Odyssee sport • Odyssee Plus



This additional bedroom is installed under the beds. Consisting of a cotton tent and a groundsheet to protect against moisture, it is ideal for the kids.

SHOCK ABSORBERS:

Odyssee sport • Odyssee Plus • Alpha • Camprider



Giving you greater driving and braking stability.

SUN CANOPY: Galleon 160 cm • Odyssee sport 190 cm

• Odyssee Plus 190 cm • Alpha 190 cm



Extend your trailer tent with a sun canopy. The shapes vary according to the models to match their design.

STORAGE BRACKET:

Galleon • Odyssee sport



In the off season, this storage bracket allows you to store your trailer tent with ease.

220V PLUG/USB PORT POWER SUPPLY

Odyssee sport • Odyssee Plus
• Alpha • Camprider • Galleon



4 x 220V plugs and 2 x USB ports

MANOEUVRING WHEELS:

Odyssee Plus GL



To effortlessly move your kitchen unit.

LUGGAGE RACK:

Galleon • Odyssee sport • Odyssee Plus



To transport suitcases or up to 3 bikes, (bike carrier not provided).

MESH FLYSCREENS:

Odyssee sport • Odyssee Plus



Replace the doors with mesh flyscreens during hot summer days.

OFF-ROAD TOWBAR STORAGE BOX 240L:

Galleon • Odyssee sport • Odyssee Plus • Alpha STD

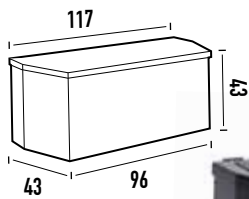

Indispensable for transporting a fridge, a WC, a bottle of gas, etc.

TOWBAR STORAGE BOX 300L:

Galleon • Odyssee sport • Odyssee Plus

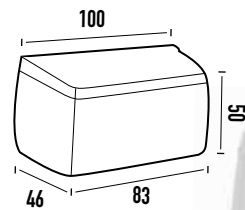

Indispensable for transporting a fridge, a WC, a bottle of gas, etc.

LUXURY TOWBAR STORAGE BOX 240L:

Galleon • Odyssee sport • Odyssee Plus

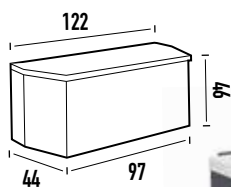

Indispensable for transporting a fridge, a WC, a bottle of gas, etc.

TOWBAR STORAGE BOX 300L:

Galleon • Odyssee sport • Odyssee Plus • Alpha STD

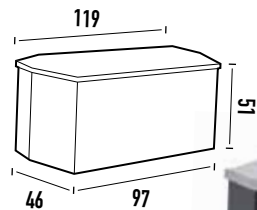

Indispensable for transporting a fridge, a WC, a bottle of gas, etc.



YOUR DEALER:

ZA LA-CROIX-DES-MARAIS
LA-ROCHE-DE-GLUN / 26 603 TAIN
L'HERMITAGE CEDEX
T. +33 (0)4 75 84 85 00 / F. +33 (0)4 75 84 85 01

WWW.TRIGANO-CAMPING.COM



This document is not contractually binding. The manufacturer reserves the right to make changes without notice.
TRIGANO HDC - RCS PARIS B 775 735 020. Design & creation: mano.fr - Photos: Ad'hoc - shutterstock